

Data Sheet



Article number: 021816011169

Description: Clamp with bracket and rubber
SPGU 6011. 169/30 SK

Measures

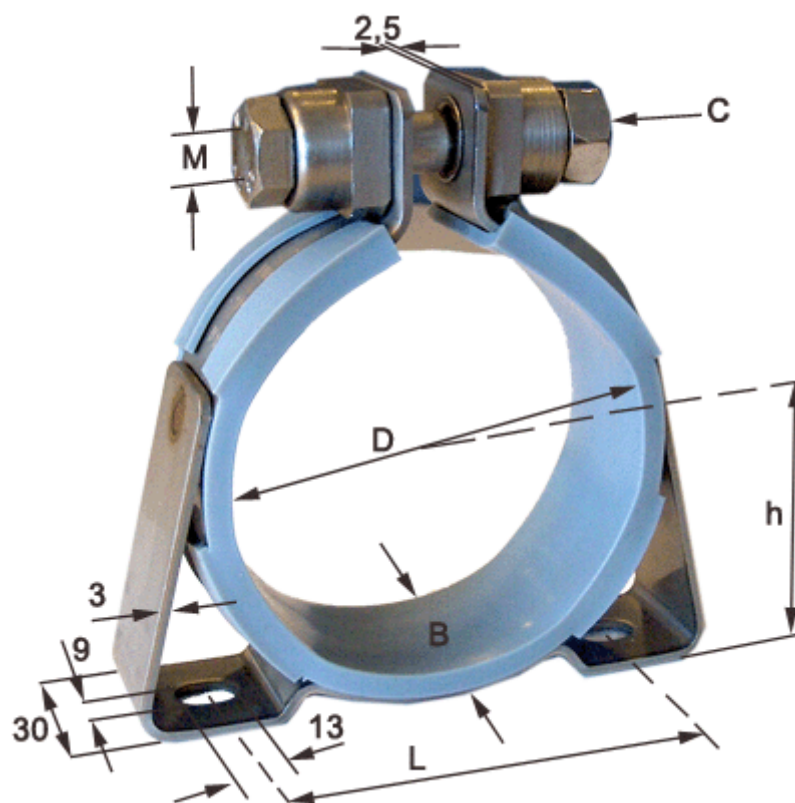

C (screw type) = SK hexagon screw

Diameter D = 169

h = 93

L = 148

Width B = 30